

Hydrogen (H₂) Sensor 110-0XX

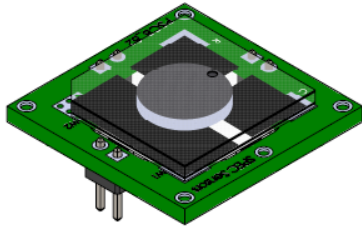

110-005
Pinned

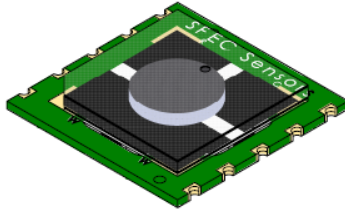

110-006
Thin
Castellation

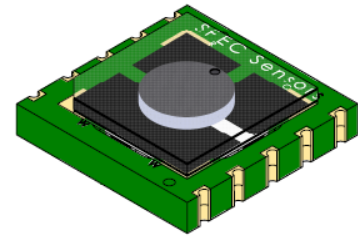

110-007
Thick
Castellation

DESCRIPTION

Interlink Electronics Screen Printed Electrochemical sensor (SPEC Sensor™) revolutionizes the current state of the art, enabling new applications in consumer, medical and industrial safety. Interlink Electronics offer the performance of the best quality electrochemical sensors at a fraction of the price. The 110-0xx family Hydrogen sensors are small and low-profile, facilitating easy integration into wireless, portable, and other IoT solutions. These sensors are ideal for health, environmental, industrial, and residential monitoring, because of their high performance, low cost, and small size. IE'S Hydrogen Sensor are available in three packages (110-005, 110-006, 110-007).

BENEFITS

- Small Size & Low Profile
- Improved Stability and low ppm sensitivity
- Accurate & Linear Response
- Long Life (10 +years)
- Fast Response
- 100% Factory Tested
- Ultra-Low Power
- ROHS Compliant

APPLICATIONS

- Health & Wellness
- Industrial Safety
- Hydrogen Transportation
- Hydrogen Usage
- Hydrogen Production
- Hydrogen Power Generation

BASIC MEASURING CIRCUIT

The diagram at the right shows the basic measuring circuit of SPEC sensors. The sensor generates an electric current which is converted into sensor output voltage (V_{out}) by an op-amp/resistor combination.

Notes: V_{bias} = V_w-V_r

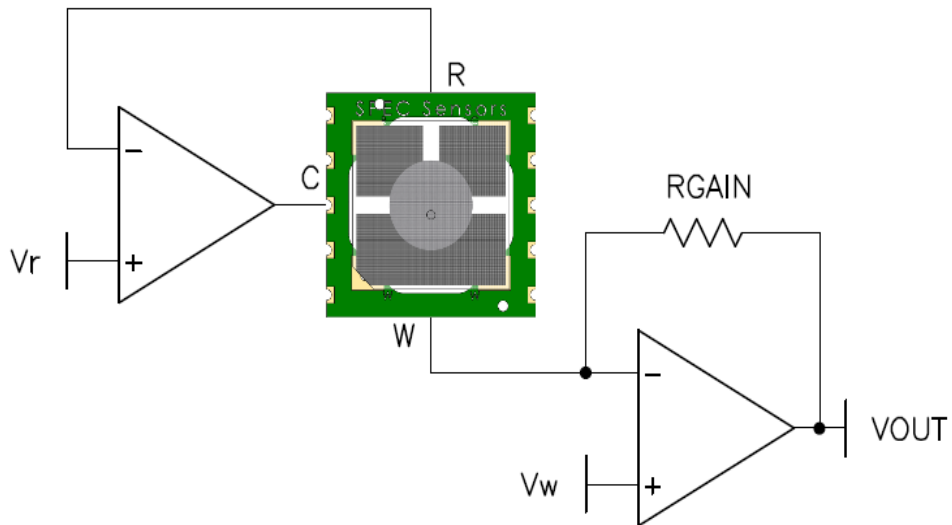

Hydrogen (H₂) Sensor 110-0XX

TABLE OF CONTENTS

Description.....	1
Benefits.....	1
Application.....	1
Basic Measuring Circuit.....	1
Specifications.....	3
Cross Sensitivity	3
Accuracy.....	4
Linearity.....	4
Temperature effect.....	5
Important Precautions	6
Marking Information	7
Ordering Information	7
Storage and Handling.....	8
Dimensions 110-005 Pinned Package	9
Dimensions 110-006 Thin Castellated Package.....	10
Dimensions 110-007 Thick Castellated Package	11

SPECIFICATIONS

Description	Typical	Unit	Notes
Measurement Range	0 to 250	ppm	1,2,3
Lower Detection Limit	1	ppm	1,2
Resolution	0.5	ppm	1,2
Accuracy	± 1	%	1
Response Time – T (90)	< 60	seconds	1
Sensitivity Range	4 ± 2	nA/ppm	1
Expected Operating Life	10	years	1
Operating Temperature Range	-5 to 50	°C	3
Operating Humidity Range	10 to 95	%	3,4
Operating Pressure Range	0.8 to 1.2	atm	3
Operating Bias Range	+25	mV	
Power Consumption	10 to 50	uW	2

1. At standard conditions (25 °C, 50% RH, 1 atm), unless otherwise indicated.
2. Depends on circuit design.
3. Recommended operating range, The sensor may be damaged, and warranty voided if operated outside the specified range. For the best optimum accuracy operate sensor at 0 to 40 °C and 15 to 90 % RH.
4. Non-condensing.

CROSS SENSITIVITY

Most chemical sensors exhibit some cross-sensitivity to other gases. The following table lists the relative response of common potential interfering gases, and the concentration at which the data was gathered.

Gas/Vapor	Concentration PPM	Typical Response as PPM H2
Hydrogen	200 ppm	200
Carbon Monoxide	400 ppm	4.1
Nitrogen Dioxide	5 ppm	0.2
Ozone	0.82 ppm	0
Sulfur Dioxide	10 ppm	0
Hydrogen Sulfide	25 ppm	0
Ethanol	200 ppm	-10.8
Formaldehyde	10 ppm	-0.7
Ethylene	50 ppm	185.6
Chlorine	10 ppm	-0.2
Nitric Oxide	10 ppm	0.3
Ammonia	100 ppm	0

ACCURACY

The Figure shows response of a set of 12 sensors exposed 4 times 200 ppm H₂ test gas. Data showed sensors accuracy at 200 ppm within less than $\pm 1\%$. Sensors are calibrated at 200 ppm test gas.

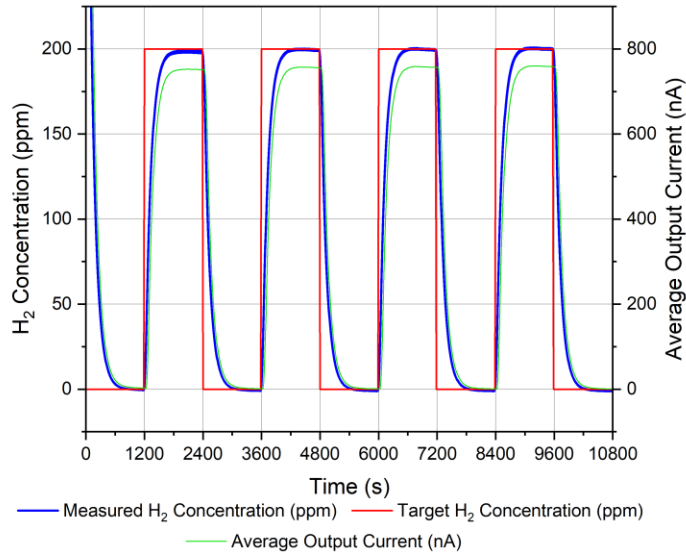

LINEARITY

The Figure shows response of a set of 12 sensors exposed to 50, 100, and 200 ppm H₂ test gas. Data showed sensors output is linear from 0 to 250 ppm test gas. Sensors are calibrated at 200 ppm H₂ gas.

This stepped gas test shows the robustness of the sensor with fast response at each step.

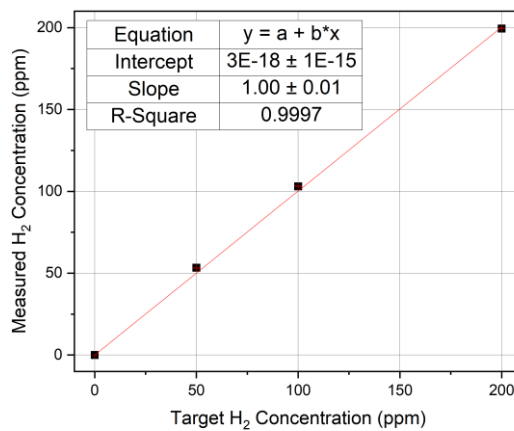
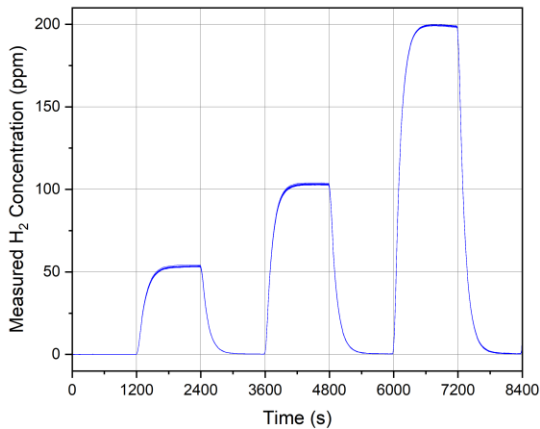

TEMPERATURE EFFECT

Temperature fluctuations have a predictable, easily compensated effect on the sensor signal. The figures below show the typical Temperature dependency of the output and baseline of H2 sensor under constant humidity of 40-50 % RH. This is a very uniform and repeatable effect, easily compensated for in hardware or software.

Baseline (Normalized to 20 C):

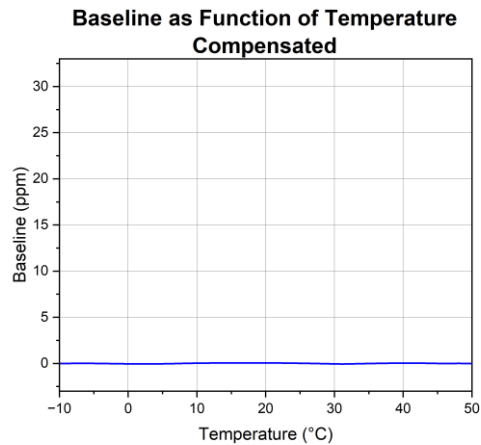
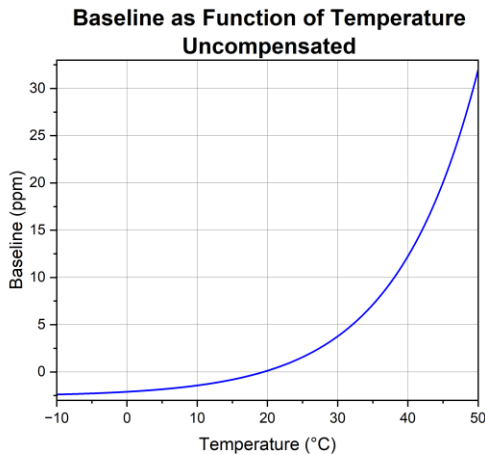

Sensitivity (Normalized to 20 C):

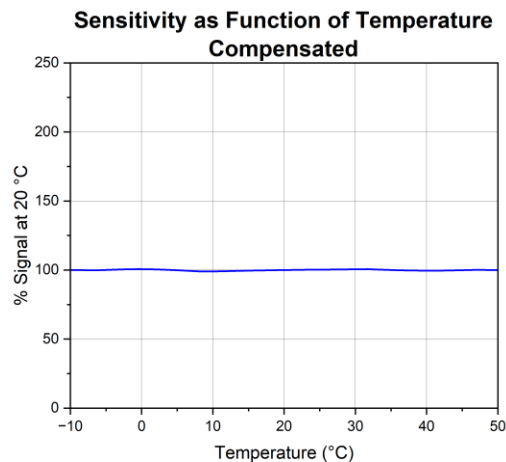
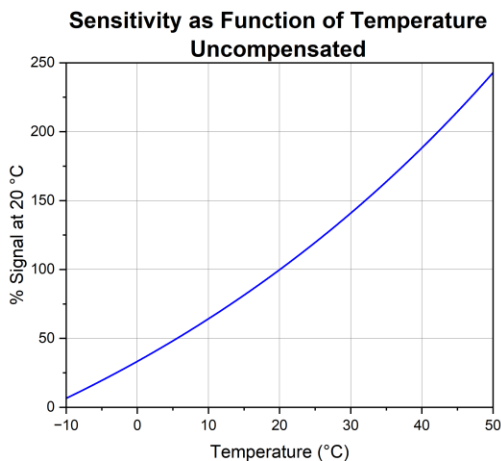

IMPORTANT PRECAUTIONS

All sensor designs are made for air monitoring @ 1 atm +/- 0.2 atm. Because applications of use and device implementation are outside our control, SPEC Sensors cannot guarantee performance in a given device or application, and disclaims any and all liability, therefore.

Customers should test under their own conditions to ensure the sensors are suitable for their requirements.

Contact the factory to discuss specific concerns that might damage the sensor performance or life.

- Condensation and Water (1)
 - Saltwater Contamination (1)
 - High Temperature Operation (> 70C) for more than 1 month
 - Low Humidity Operation (< 15% RH) for more than 3 months
 - High Bias voltage
 - Highly contaminated air over a prolonged period
 - High levels of particles or soot (unless proper filtering is provided)
- (1) Use of porous PTFE membrane or filter cap may address this concern)

MARKING INFORMATION

All gas sensors are tested and marked at the Interlink electronics factory. Sensors include a label with an alpha-numeric code and a two-dimensional bar code. The codes include the information indicated in the table below.

	Sensor Serial Number	Sensor Part Number	Target Gas	Date Code (YYMM)	Sensitivity (nA/ppm)
Alpha-Numeric Code					
Two-Dimensional(2D) bar code	021623020258	110005	H2	2305	3.54

ORDERING INFORMATION

Part Number	Package
110-005	Pinned
110-006	Thin Castellation
110-007	Thick Castellation

SENSOR STORAGE, HANDLING AND SOLDERING

This information embodies various general recommendations concerning the storage, handling, and manual soldering conditions for Sensor. Moreover, sensors are NOT warranted and should NOT be used in high temperature soldering (reflow) or pre-tinning baths.

Sensor & Module Handling

Handle sensors with care. Take precautions, including but not limited to the following:

- A. DO NOT apply excessive pressure to the top or bottom of the sensor module.
- B. Whenever possible, handle or contact the sensor module from the sides of the PCB or substrate.
- C. Light vacuum pressure is possible during handling, DO NOT apply vacuum over gas sensor port.
- D. If the sealed sensor package is opened, DO NOT re-seal use vacuum or nitrogen gas. DO NOT reseal with desiccant.
- E. DO NOT obstruct the gas sensor port by making direct contact with any tape, apparatus, weights, etc.
- F. DO NOT use silicone or other conformal coatings around the sensor or gas portholes.
- G. Operators are requested to wear powder-free antistatic gloves.

Manufacturing Assembly Floor Environment

Interlink Electronics recommends that the manufacturing assembly floor environment be maintained at controlled conditions:

- A. Temperature: 18 - 26°C
- B. Relative Humidity: 40 to 60%
- C. Pressure: 1.0 ± 0.2 atm

Sensor & Module Storage Conditions

The shelf life for sealed, packaged components is 12 months from the pack seal date, when stored in the factory-sealed bag under the following conditions:

- A. Temperature: 5 to 25 °C
- B. Relative Humidity: 20 to 80%
- C. Pressure: 1.0 ± 0.2 atm
- D. Storage Time: 12 months

When moving from Storage Conditions to the Manufacturing Assembly Floor Environment, the sensors should be allowed to equilibrate at the new conditions for at least 24 hours prior to manufacturing.

Module Attach Soldering Process

Hand solder only. Keep the soldering iron or solder process tool away from the sensor. The sensor should not see pre-heat temperatures above 70 °C. There have been suggested cases where a heat sink cover over the sensor may be applicable to protect the sensor during processing. No Application notes to this approach available. Only to be used as reference only.

- A. DO NOT heat sensor above 70 °C.
- B. Hand or peripheral process type approach
- C. Use solder wire alloy with the lowest possible eutectic temperature.
- D. Use the lowest possible soldering iron temperature.
- E. Contact the host board with the soldering iron at a 45° angle on the solder pad.
- F. Keep the soldering iron away from the top and bottom of the sensor module.
- G. DO NOT place in reflow, wave or IR reflow type processes.
- H. DO NOT place mounted board in a wash.



SPEC-Sensors.com代理商联系方式:

样品, 报价, 评估板, 参考设计, 技术支持

电话: 0755-82565851

邮件: dwin100@dwintech.com

手机: 156-2521-4151

网址: http://www.dwintech.com/Gas_Sensor_Pamphlet.html

深圳市南频科技有限公司

D-Win Technology (HongKong) Co., Ltd